

| REV | LOCATIONS | DESCRIPTION | DATE | REVISER | APPD |
|-----|-----------|-------------|------|---------|------|
| | | | | | |

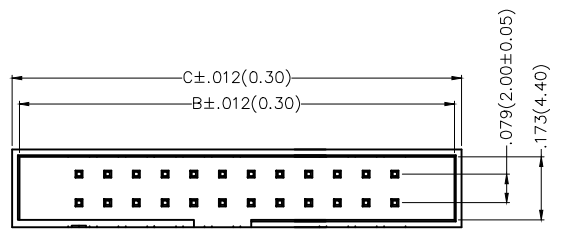

Electrical
 Current Rating: 2.0A AC(rms)/DC
 Voltage Rating: 250V AC(rms)/DC
 Contact Resistance: 20 mΩ Max
 Insulation Resistance: 1000 MΩ Min
 Withstanding Voltage: 500V AC r.m.s
 Temperature Range—Operating: -40°C~+105°C
 Material and Plating
 Housing: Glass Filled Polyester (UL 94V-0)
 Pin: Brass
 Pin plating: Gold Plated

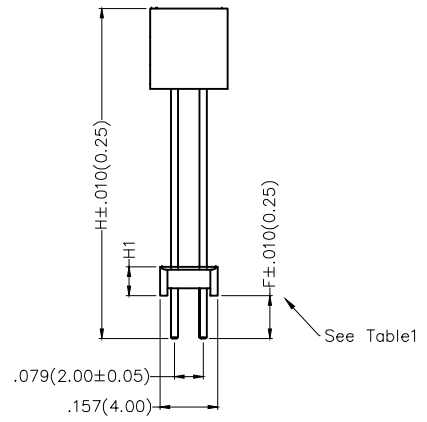
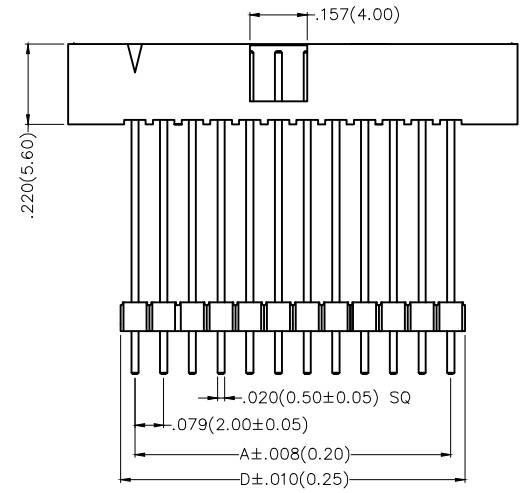

Ordering Information

FBH 200 19 — D XX S 1 XX X K6 X XX
 1 2 3 4 5 6 7 8 9 10 11 12

| | | | | | |
|------------------------------|-----------------------------------------------------------------------------|-------------------------------------|------------------------------|----------------------------------|-------------------------------------------------------------------------------|
| 1 Category FBH-Box Header | 2 Series Number 200-Pitch2.00mm | 3 Distinction No. 19 | 4 Row Option D-Double Row | 5 Circuits XX | 6 Entry Angle S-180° Vertical |
| 7 Plating 1-Gold plated | 8 Thickness of Plating 00-Gold Flash 03-3μ" Custom plate available | 9 Material-Resin 4-PA9T 3-LCP | 10 Color-Resin K6-Black | 11 Packaging K-Tray L-Tube | 12 Size 01,02... -Serial number (See Table1) Custom Length Available |

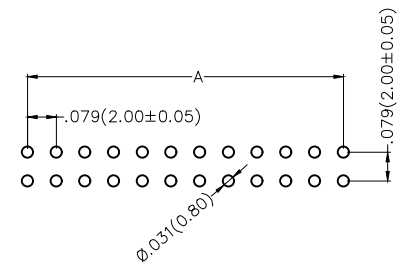

Recommended P.C.Board Layout

| | | | | | | | |
|------------------------|---------------------------------------|-----------------------------------------------------------------------|-------------------------------------------|----------------------|----------------------------------------------------------------------------------------------------------------------------------------------------|--------------------------------------------------------------------|-------------------------------------------------------------------------------------------------------------|
| THIRD ANGLE PROJECTION | GENERAL TOLERANCES (UNLESS SPECIFIED) | | APPROVE BY FRANK | DATE 29/AUG/16 | PART NO. FBH20019-DXXS1XXXK6XXX | ITEM NO. FBH20019 |  Leader Of Industry |
| | DESIGN UNITS Inch (metric) | X±.012(0.30) X.X±.008(0.20) X.XX±.006(0.15) X.XXX±.004(0.10) | X.'±5' .X'±2' .XX'±1' .XXX'±0.5' | CHECKED BY CHERRY | DATE 29/AUG/16 | TITLE Wire to Board(Box Header) Pitch 2mm Vertical 180°(DIP) | |
| SCALE 5:1 | SIZE A4 | DRAWN BY KATE | | DATE 29/AUG/16 | THIS DRAWING CONTAINS INFORMATION THAT IS PROPRIETARY TO TXGA INDUSTRIAL ELECTRONICS(S.Z)CO.,LTD AND SHOULD NOT BE USED WITHOUT WRITTEN PERMISSION | | |

| REV | LOCATIONS | DESCRIPTION | DATE | REVISER | APPD |
|-----|-----------|-------------|------|---------|------|
| | | | | | |

Table1

| Serial number | Dimensions(in/mm) | | | Canceled No. | Note |
|---------------|-------------------|------------|------------|--------------|------|
| | H | H1 | F | | |
| 01 | .799(20.30) | .079(2.00) | .110(2.80) | — | |
| 02 | .669(17.00) | .079(2.00) | .079(2.00) | — | |
| 03 | .378(9.60) | .059(1.50) | .098(2.50) | — | |
| | | | | | |
| | | | | | |
| | | | | | |
| | | | | | |
| | | | | | |
| | | | | | |
| | | | | | |
| | | | | | |
| | | | | | |
| | | | | | |
| | | | | | |
| | | | | | |
| | | | | | |
| | | | | | |
| | | | | | |
| | | | | | |
| | | | | | |
| | | | | | |
| | | | | | |
| | | | | | |
| | | | | | |
| | | | | | |
| | | | | | |
| | | | | | |
| | | | | | |
| | | | | | |

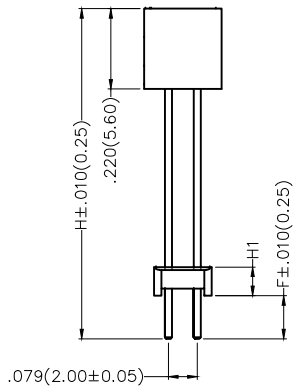

| | | | | | | | | |
|----------------------------|---------------------------------------|-------------------------|------------------------|------------------|------------------------|-----------|----------------------------------------------------------------------------------------------------------------------------------------------------|---------------|
| THIRD ANGLE PROJECTION | GENERAL TOLERANCES (UNLESS SPECIFIED) | | APPROVE BY | DATE | PART NO. | ITEM NO. | Leader Of Industry | |
| | $X \pm .012 (0.30)$ | $X \cdot \pm 5'$ | FRANK | 29/AUG/16 | FBH20019-DXXS1XXXK6XXX | FBH20019 | | |
| | DESIGN UNITS Inch (metric) | $X.X \pm .008 (0.20)$ | $X \cdot \pm 2'$ | CHECKED BY | DATE | TITLE | REV 0 | SHEET NO. 2/3 |
| | SCALE 5:1 | SIZE A4 | $X.XX \pm .006 (0.15)$ | $X \cdot \pm 1'$ | CHERRY | 29/AUG/16 | THIS DRAWING CONTAINS INFORMATION THAT IS PROPRIETARY TO TXGA INDUSTRIAL ELECTRONICS(S.Z)CO.,LTD AND SHOULD NOT BE USED WITHOUT WRITTEN PERMISSION | |
| | | $X.XXX \pm .004 (0.10)$ | $X \cdot \pm 0.5'$ | DRAWN BY | DATE | | | |
| | | | KATE | 29/AUG/16 | | | | |

1 2 3 4 5 6 7 8

| REV | LOCATIONS | DESCRIPTION | DATE | REVISER | APPD |
|-----|-----------|-------------|------|---------|------|
| | | | | | |

A

A

B

B

C

C

D

D



E

E

F

F

| Circuits (n) | Part No. | Dimensions(in/mm) | | | |
|--------------|------------------------|-------------------|--------------|--------------|--------------|
| | | A | B | C | D |
| 6 | FBH20019-D06S1XXXK6XXX | .157(4.00) | .484(12.30) | .524(13.30) | .236(6.00) |
| 8 | FBH20019-D08S1XXXK6XXX | .236(6.00) | .563(14.30) | .602(15.30) | .315(8.00) |
| 10 | FBH20019-D10S1XXXK6XXX | .315(8.00) | .642(16.30) | .681(17.30) | .394(10.00) |
| 12 | FBH20019-D12S1XXXK6XXX | .394(10.00) | .720(18.30) | .760(19.30) | .472(12.00) |
| 14 | FBH20019-D14S1XXXK6XXX | .472(12.00) | .799(20.30) | .839(21.30) | .551(14.00) |
| 16 | FBH20019-D16S1XXXK6XXX | .551(14.00) | .878(22.30) | .917(23.30) | .630(16.00) |
| 18 | FBH20019-D18S1XXXK6XXX | .630(16.00) | .957(24.30) | .996(25.30) | .709(18.00) |
| 20 | FBH20019-D20S1XXXK6XXX | .709(18.00) | 1.035(26.30) | 1.075(27.30) | .787(20.00) |
| 22 | FBH20019-D22S1XXXK6XXX | .787(20.00) | 1.114(28.30) | 1.154(29.30) | .866(22.00) |
| 24 | FBH20019-D24S1XXXK6XXX | .866(22.00) | 1.193(30.30) | 1.232(31.30) | .945(24.00) |
| 26 | FBH20019-D26S1XXXK6XXX | .945(24.00) | 1.272(32.30) | 1.311(33.30) | 1.024(26.00) |
| 28 | FBH20019-D38S1XXXK6XXX | 1.024(26.00) | 1.350(34.30) | 1.390(35.30) | 1.102(28.00) |
| 30 | FBH20019-D30S1XXXK6XXX | 1.102(28.00) | 1.429(36.30) | 1.469(37.30) | 1.181(30.00) |
| 34 | FBH20019-D34S1XXXK6XXX | 1.260(32.00) | 1.587(40.30) | 1.626(41.30) | 1.339(34.00) |
| 36 | FBH20019-D36S1XXXK6XXX | 1.339(34.00) | 1.665(42.30) | 1.705(43.30) | 1.417(36.00) |
| 40 | FBH20019-D40S1XXXK6XXX | 1.496(38.00) | 1.823(46.30) | 1.862(47.30) | 1.575(40.00) |
| 44 | FBH20019-D44S1XXXK6XXX | 1.654(42.00) | 1.980(50.30) | 2.020(51.30) | 1.732(44.00) |
| 50 | FBH20019-D50S1XXXK6XXX | 1.890(48.00) | 2.217(56.30) | 2.256(57.30) | 1.969(50.00) |
| 60 | FBH20019-D60S1XXXK6XXX | 2.283(58.00) | 2.610(66.30) | 2.650(67.30) | 2.362(60.00) |

| | | | | | | | |
|----------------------------------------------------------------------------------------------------------------|---------------------------------------|---------------------------------------------|------------------------------------------------------|-------------------|--------------------------------------------------------------------|----------------------------------------------------------------------------------------------------------------------------------------------------|-------------------------------------------------------------------------------------------------------------|
|  THIRD ANGLE PROJECTION | GENERAL TOLERANCES (UNLESS SPECIFIED) | | APPROVE BY FRANK | DATE 29/AUG/16 | PART NO. FBH20019-DXXS1XXXK6XXX | ITEM NO. FBH20019 |  Leader Of Industry |
| | DESIGN UNITS Inch (metric) | X.±.012(0.30) X.±5' X.X±.008(0.20) X.±2' | CHECKED BY CHERRY | DATE 29/AUG/16 | TITLE Wire to Board(Box Header) Pitch 2mm Vertical 180°(DIP) | | |
| | SCALE 5:1 | SIZE A4 | X.XX±.006(0.15) .XX±1' X.XXX±.004(0.10) .XXX±0.5' | DRAWN BY KATE | DATE 29/AUG/16 | THIS DRAWING CONTAINS INFORMATION THAT IS PROPRIETARY TO TXGA INDUSTRIAL ELECTRONICS(S.Z)CO.,LTD AND SHOULD NOT BE USED WITHOUT WRITTEN PERMISSION | |

1 2 3 4 5 6 7 8